

GERNSBACK'S EDUCATIONAL LIBRARY No. 1

HOW TO BUILD 4 DOERLE SHORT WAVE SETS

10
CENTS



EVERYTHING
*about **ALL***
the famous
DOERLE
RECEIVERS

RADIO PUBLICATIONS
101 HUDSON ST., NEW YORK CITY

Suggest A Good Book Title

WIN TEN DOLLARS!

SINCE 1908, the name Gernsback has been synonymous with scientific and radio literature. Since that time, many millions of Gernsback magazines and books have been distributed and read by people all over the globe.

Recently, Hugo Gernsback decided to place upon the market a new, popular priced series of books under the name of GERNSBACK'S EDUCATIONAL LIBRARY. It is the intent of the publisher to continuously add books to the library, from time to time, under various titles. These books will cover a great many subjects, which will not necessarily be restricted to radio or science, but which will encompass many other arts.

It is Mr. Gernsback's plan to have all the books of uniform size. Their price being extremely low, everyone will ultimately be able to possess the entire library, especially since they are purchased piecemeal as the books are published.

Don't forget either, that Gernsback books and magazines always have given you your full money's worth: The present series of books again proves this. Never in the history of technical publishing have you been able to buy so much for so little money. The answer to this is in turning out a greater number of books and in large quantities.

In bringing out new books, we want your help. Perhaps you have an idea for a certain book title (subject for a new book) that you think we should publish in one of these 10c volumes. *If you have such an idea, communicate it to us; we will pay \$10.00 for each new book title which we accept. If you submit more than one title, write each one on a separate sheet of paper.* In case of a tie, identical prizes will be paid to the contestants.

Address all letters to

RADIO TITLE EDITOR

RADIO PUBLICATIONS

101 HUDSON ST. NEW YORK CITY

PRIZE WINNERS

ALFRED CETTIE

4115 Midvale Avenue
Seattle, Wash.

Title: ALL ABOUT AERIALS, Book 4

RUDY RUZICKA

3441 California Avenue
St. Louis, Mo.

Title: BEGINNERS' RADIO DICTIONARY, Book 5

KENNETH WARNER

R. F. D. No. 2,
Burbank, Ohio

Title: HOW TO READ RADIO DIAGRAMS, Book 7

CLYDE SORRELL

504 North 10th Street
Rockyford, Colo.

Title: RADIO FOR BEGINNERS,
Book 8

(Watch the List Grow)

(Copyright 1938, by H. Gernsback)
Printed in U. S.

2—TUBE 12,500 MILE "DOERLE" SHORT-WAVE RECEIVER

By W. C. Doerle

HEREWITH is the original article describing the *original* "12,500 Mile Doerle", the simple 2-tube short-wave set which has spun circles around many an elaborate commercial receiver. Simply and inexpensively constructed but with great respect for radio "losses", this set has become world-famous for its superlative performance. Follow the constructional details carefully and you will have a short-wave set "second to none."

WHAT the heck's the idea of wasting power, of blasting out ear-drums, of going "bugs" with the performance of a costly short-wave receiver, when you can build a two-tube outfit that gets signals from the 12,500 mile meridan? Why, there is nothing to brag about when you "log" a bunch of stations with a powerful receiver; but listen to a man who "pets" a two-tube set, and then you get the "thrill of a lifetime."

It's quite possible to continue the entertainment with words, but our problem is to tell how you too can get thrills that will last a lifetime. Here we go on our journey of description — hold your breath, read vigorously and absorb all details—everything is important.

Good night, my pencil is nearly worn to the wood and I haven't even let you fellows in on a diagram; but here she follows and with the losses reduced maybe to a third, because of careful and

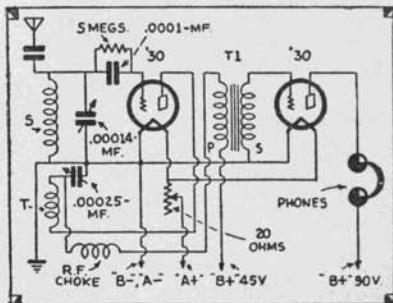

Schematic diagram of "12,500 miler."

thoughtful construction and consideration, you could very well guess it's our old timer—the *Sch-nell* method of regeneration control for the detector, and a stage of audio frequency. (See hookup diagram.)

We know that some people write backward and think forward; but let's start the discussion just as you perhaps draw a radio hook-up diagram—starting with the antenna symbol and completing the diagram with a few curves or loops to represent the output load—in our set we intend to use head “phones.”

Antenna and Ground

Now as to the antenna, a wire strung twice across the living room and anchored to the picture molding with small finishing nails, together with a good “water-pipe” ground connection, has enabled the author to pick up signals with such a receiver from stations 6,000 miles away, even on a hot summer day on the Pacific Coast (Oakland, California.) Say, fellows, if a well-insulated outside antenna had been possible of erection why the other 6,500 miles of “no-man’s land” would have been easily heard and conquered.

Time is moving along, and there is much ground yet to be gained. Let us consider for a moment the antenna “series condenser.” For the operator’s convenience, a seven-plate midget is quite suitable for the purpose; but in a small receiver of this price, a condenser made of two pieces of old condenser plates, cut to about $1\frac{1}{2}$ square inches in area and spaced on the binding-post strip $\frac{1}{8}$

in. apart, will serve very well for coupling the R.F. energy from the antenna to the oscillating circuit of the receiver.

(An adjustable padding condenser or a 35 mmf. midget variable will provide an easy way of overcoming dead spots caused by the antenna.—Editor.)

Keeping Down Those “Losses”!

Be sure that the post strip is of bakelite; as this is the cheapest, though not the best, insulation for the purpose. In some experiments made by the author, a home-made series condenser was mounted on $\frac{1}{4}$ -inch plywood baseboard, but a surprise awaited—the signal intensity as heard in the phones was about three-quarters its value when the series condenser plates were mounted on the bakelite strip. If there is nothing else to gain from this article, be sure that, when you make a two-tube set, *you keep all losses as low as possible. It's hard to compensate for them.*

Since this type of receiver would undoubtedly call for home-made plug-in coils, because of their convenience, we follow up our diagram with a discussion of this type of coil for the oscillating circuit. To hold the wire in place on the tube-base, the author has found orange shellac to have small loss, and it gives a shiny finish to the form. As to the condensers for use in this receiver, select those that have the smallest amount of dielectric in supporting the stator plates.

Use a 5-megohm leak and .0001-mf. grid-condenser. These values will make the receiver very sensitive.

Now, in our discussion we are near

the audio-frequency transformer and our eyes immediately behold an R.F. choke. Gee, what a mean thing for the temper; but, at any rate, 300 turns of No. 36 D.S.C., magnet wire, close-wound on a $\frac{1}{2}$ -in. wooden dowel, will choke the R.F. current out of the transformer primary, even at 20 meters or, use a standard SW

choke (about 2.5 mh.).

As to the audio transformer, we can't boast for any type; but a good 5 to 1 ratio and a hefty type, will be good.

If for any reason the set should fail to work, the first place to look for the trouble is in the coil connections. In connecting the coil make

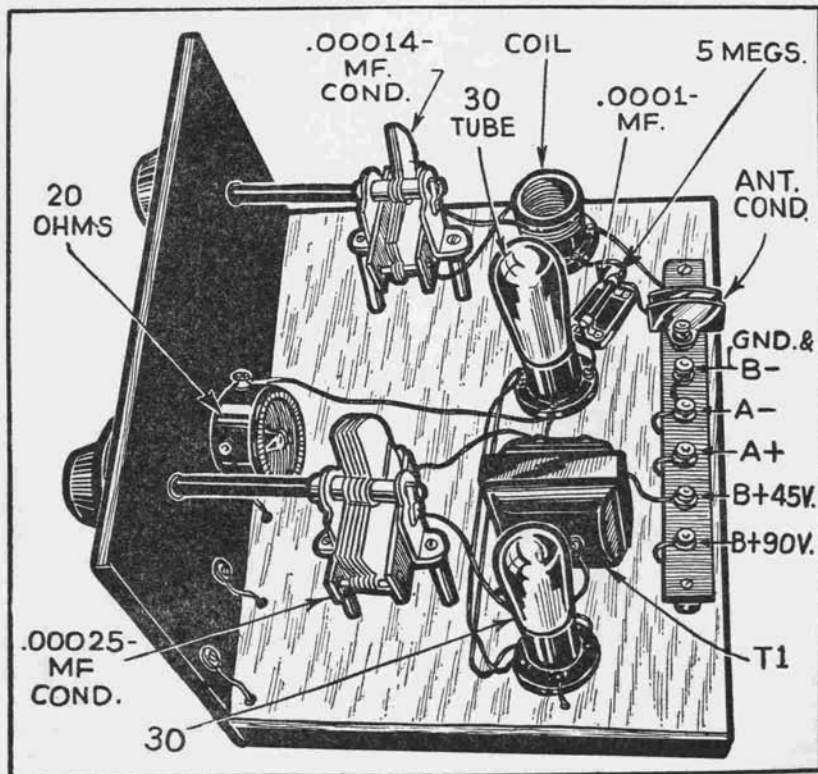

Illustration showing placement of parts.

sure that the end of the grid coil which is farthest from the tickler is connected to the grid-leak and grid-condenser. The other terminal of the grid coil goes to the A minus. The tickler is connected so that the lead farthest from the grid coil goes to the plate of the tube. And the other side of the tickler goes to the regeneration control (condenser) and to the primary of the audio transformer. If the above instructions are followed the detector tube should oscillate.

Failure of the tube to oscillate may be due to the antenna being too closely coupled to the grid coil. While the diagram shows a home-made antenna coupling condenser, it is much better to use a small variable condenser which can be adjusted to suit the particular antenna which is used. Before you assemble and wire the set, make sure that all parts are in good condition and there will be no reason for failure. The above hints apply to the construction and wiring of all short wave sets using two winding coils.

The following is a list of parts for the set proper:

List of Parts

One Bakelite panel 7 x 10 in.;
 One Baseboard 9 x 11 in.;
 Three 4 prong sockets;
 One Tuning condenser .00014-mf.;
 One Throttle condenser .00025-mf.;
 Two condenser plates 1½ inches square;
 Seven terminal post-strip;
 Seven binding posts;
 Five megohm grid-leak;
 One .0001-mf. grid condenser;
 One 5:1 transformer;
 Two telephone binding posts;
 Two 3 in. dials, (vernier type are best);
 One 20-ohm rheostat;
 Hook-up wire, screws, etc.

Coil Data

Range (meters)	Turns	
	S	T
15-45	5	6
35-75	9	5
60-125	16	6

All coils are close-wound with No. 24 enamelled copper wire, and with no spacing between S and T.

MORE ABOUT THE 12,500 MILE DOERLE SET

IN the first article, Mr. Doerle described at length his interesting short wave receiver, which is capable of picking up signals from almost anywhere, depending on the parts used. It goes without saying that if cheap parts and an insensitive pair of phones are

used, that one cannot hope to hear far-distant signals. Let's go on with Mr. Doerle's tale:

Let it be understood here that all tube-base coils are not going to act alike in the detector stage. Some bases are made of genuine bakelite, while others are made of an extra

hard "tar" or "composition." You will probably appreciate that fact better if you get some experience in drilling small holes in these bases with the use of a power-driven drill press. In some instances, the drill must be forced for cutting action; while in others, the drill eats in as though it were going through cardboard.

"What" Tube Base Is Important

But you will probably say — "What difference do tube bases make?" Here is the explanation. Since we want a maximum signal voltage existing between the grid and filament of the detector tube, that means the oscillating circuit should have a maximum impedance (for it is a tuned circuit); and, if a high resistance is in parallel with the oscillating circuit (the losses constituting part of this resistance, because the condenser tuning across the coil also has losses), this resistance determines the voltage drop from grid to filament. Not only for this reason do we want "low losses" in the oscillating circuit, but for another which regards the amount of feed-back energy from the plate circuit, via the tickler coil and the throttle condenser. The lower these losses, the smaller can be the tickler coil and feed-back condenser capacity. To hold the wire in place on the coil forms use a few drops of shellac or rubber cement.

Now that the oscillating circuit has withstood the fire, and emphasis has been laid on the importance of cutting down its losses to a low value, shall we now throw away our labor and have a poor, insensitive receiver, by taking no precautions in the selection of other

parts? By no means, and we intend to fight until the globe is encircled and we can hear the "peeps" from a "5-watter" at the 12,500-mile meridian. We started out after signals, records, "logs," and the whole field of short waves to show the "rich" man that a "super" midget radio still exists in poor Lazarus' field.

That R.F.—Choke—Its Pedigree!

300 turns of No. 36 D.S.C., magnet wire, close-wound on a 1/2-in. wooden dowel, will choke the R.F. current out of the audio transformer primary, even at 20 meters. This can be verified by pressing the phone cord in the hand while the set is operating. If no change occurs in the received audio notes, the choke is performing its duty.

Try Different Grid Leaks and Condensers!

Try different leak-condenser values; by the time you have done this and have soldered some of these grid-condensers in place and used leaks thereon, you will probably give up in disgust and say, "Aw shoot! Let's take the other fellow's values to save time and trouble." After going through part of such an experiment, even to getting knuckle burns from the hot iron, take a tip and use the values given herein—5 megohm leak and .0001-mf. grid-condenser. These values will make the receiver very sensitive and, if you listen in the phones, to notice how the back-ground-noise level comes into prominence, when using the throttle condenser on increasing its capacity for feedback, you will greatly commend the receiver for its sensitivity. Also notice the "softness" of feedback (no spilling

over) with "power plus" and "free wheeling." Aren't you getting anxious to "work" one of these receivers?

As to the audio transformers, a good 5 to 1 ratio and a hefty type, will certainly make the signals more prominent in the phones. Oh! that the day would come when radio parts would be sold by weight, and prices could be vetoed! Phones! phones! and we must have a pair, but let's not be guilty of innocent blood. Just buy a pair large enough to cover nearly the whole ear and, together with that, with enough weight. The "skinny make" of phones always give the signals a mouse-squeak background, at least that's been my experience.

Before proceeding further, the circuit is checked against the wiring diagram, preferably with a continuity meter (volt-meter with series battery or ohmmeter).

Efficiency of Battery Tubes

Didn't we say in the beginning

that power should not be wasted? Well, let's back up our words with action and use the '30 (2-volt filament) type of tubes—the tubes with the '99 economy, but '01A amplification and output. Can you imagine this economy—two dry cells and 90 volts of "B" battery for at least six months of pleasure at a cost of 2.50—only about \$0.50 a month!

Short-wave stations are growing more numerous; and the time to build this "super midget" and get a long "log" of stations is now.

Suggestions and Parts

The simplicity of the hook-up and photo has warranted us not to give a mass of details for constructing this receiver; for we believe that by so doing, the ingenuity of the builder has free course with the parts he may have available. The tubes burn at a dull red color when two volts are impressed on the filaments.

THE "DOERLE" 3-TUBE SIGNAL GRIPPER

By W. C. Doerle

FOR a long time no single article has occurred in print which gives the "babe" the outstanding principles of operation and description of a short-wave set. Not only do the following paragraphs remedy the ill, but supply the "food" for the two classes of will-be short-wave enthusiasts.

30 Minutes of Short-Wave Education

For the facts that are of outstanding importance, and that will soon be elaborated, assume that the neophyte has listened to a friend's short-wave receiver bring in distant signals and that from such an "audition" he has received his inspiration to construct a receiver that will afford him pleasure in his home. No doubt he also has searched through short-wave magazines to find out which materials and radio parts are necessary for the construction of a set—one that fits the leanness or fatness of his purse—but is at a great loss to get a panoramic view of the whole situation. If the "beginner" goes too blindly at the construction of a short-wave set, he will be addressing many letters to radio editors, set manufacturers, and companies selling radio parts, asking for help with his difficulties; whereas if he knew the facts about short-wave receiver operation and construction, he would be amazed at his tech-

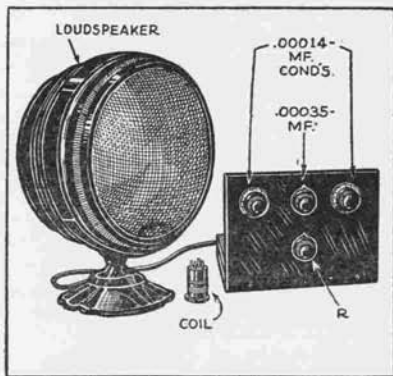

"Signal Gripper" Works Loudspeaker.

nique and "trouble-shooting" for the "needle in the haystack."

Since the story is getting somewhat lengthy already, it is necessary at this point to give a hook-up of a short-wave set that involves all the principles which will be explained in the text. This diagram for a set would be called a three-tube hook-up, embodying a stage of R.F. (radio frequency) amplification, a regenerative detector (DET.) and a stage of A.F. (audio frequency) amplification. As a battery set has such a versatility of use (portable, can be operated in an automobile, affords much pleasure while rolling along with the breeze, can be operated in wooded lands, and in short is inde-

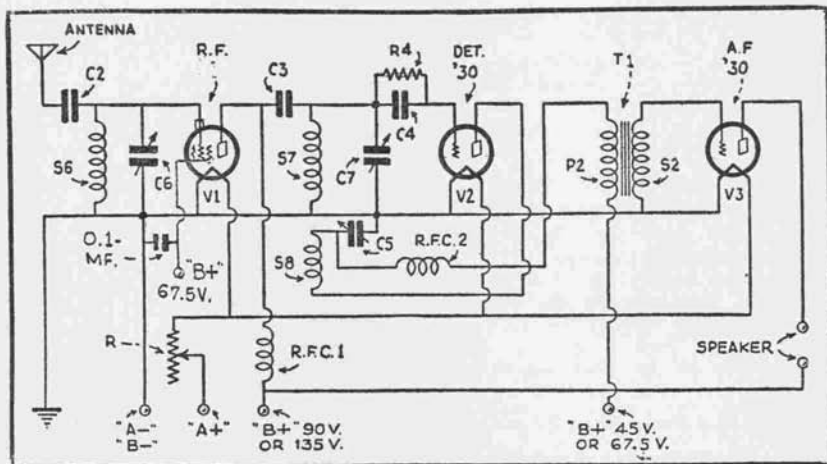

Schematic Diagram of the Doerle "Signal Gripper." R. F. stage, uses a 32 screen grid tube.

pendent of all external circumstances), the diagram and photographs show the use of the '30 two-volt tubes, which require two dry cells in series for filament-supply current.

The important items which come up for consideration can be grouped around five elements — antenna, radio frequency amplifier, detector, audio frequency amplifier and output device. It cannot be too strongly emphasized that the neophyte should make a study of these elements for by so doing his radio education will become rounded out. (Be it made known here that all facts are not brought to light, but only those which are of the utmost value to the beginner—if all were included, there would be volumes instead of a few pages.)

How Antenna and R.F. Stage Work

For the antenna element, this is not "just a wire insulated in the air," but an oscillating circuit which is composed of the wire (as the inductance) and its inherent capacity (as the condenser) to its image below the ground surface and to nearby objects above the surface. Its function is to intercept the radio waves and by the use of condenser C2 electrostatically couple this R.F. energy to that oscillating circuit made up of coil S6 and condenser C6.

This leads to a consideration of the stage of radio frequency. If S6-C6 be tuned to the wavelength of the transmitted signal, then a very high value of oscillating current is set up in S6-C6, which in turn establishes a large value of R.F. voltage between the grid and filament nega-

tive connection of tube V1. As this stage is called an R.F. amplifier, its function is to enlarge the amplitude of the R.F. voltage that will act on the grid of the detector (DET.). This amplified voltage is due to the inherent characteristic of any screen grid radio tube. (If the beginner will consult an up-to-date book on principles of radio communication, he will see very readily why such a tube acts as an amplifier — the curve of grid voltage versus plate current should be convincing proof.) But the discussion of the R.F. stage does not end here — the RFCI- (radio frequency choke coil) still must be considered. It acts as the plate "load" (for without a load, the tube will not amplify), and while one end, nearest the plate, is "alive," the other end

should be practically at zero potential or "dead" if properly constructed. (use standard 2.5 mh. choke.)

Thus, succinctly stated, a stage of R.F. is used to get large enough values of grid voltage "swing" in the detector oscillating circuit S7-C7, so that the plate current of tube V2 will cause a reasonable amount of magnetization of the iron in the primary winding P2 of the audio transformer T2. But before proceeding too far, it is well to state here that coils S6, S7, and condensers C6, C7, have the same number of turns and capacities respectively.

Since the plate end of RFC1 is "alive" with R.F. voltage and if the oscillating circuit S7-C7 of the detector stage be tuned to the same frequency as that in S6-C6, then it

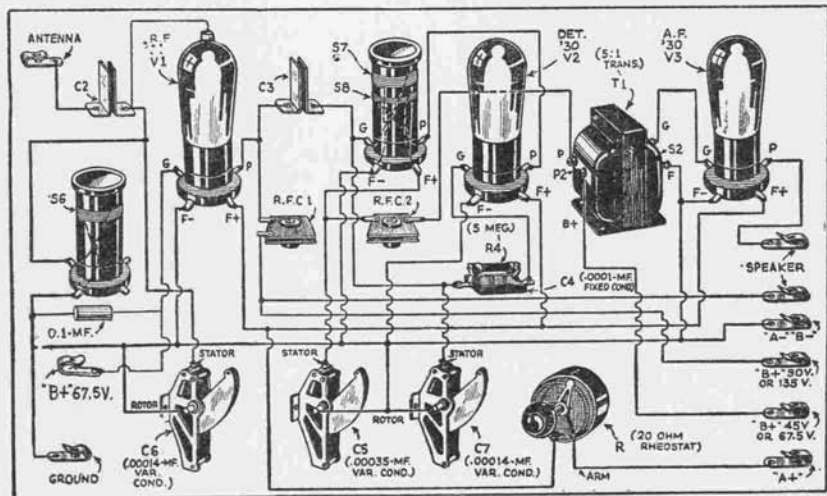

Pictorial Diagram Showing Placement of Parts. R. F. stage uses a type 32 tube.

acts as a wavemeter, and coupling of the R.F. and detector stage takes place through condenser C3. As listed in the circuit constants (C2 equals C3), these condensers are made of thin copper sheet cut to 1 x 1¼ inches and spaced 1/16 inch apart on the baseboard with their longest dimension folded ¼ inch, thus making effective areas of 1 x 1 inch. (If these are made too large, broadcast harmonics will "peep in" and also may cause *blocking* of the detector; if made too small, C3 will have such a high reactance in the region of 150-200 meters that these signals will not be *detected*. In other words not enough coupling will exist between the R.F. and detector stage in this region of wavelengths.)

The Detector Stage

Passing so closely to the brink of the stream, it is time to take a drink of that which pertains to the *detector* stage. This is made up of the coils S7 and C8, condensers C5 and C7, and tube V2 with its grid-leak R4 and grid condenser C4. The tickler coil serves as the "power" source for regeneration, while the condenser C5 has the purpose of throttling this *feed-back* energy. If the oscillating circuits S6-C6 and S7-C7 are tuned exactly to the same wavelength (the condition for clear short-wave phone reception), no audible sound comes from the speaker. However, for *code* reception C7 is detuned somewhat so that an audible beat-note suitable to the listener's ear can be heard. Thus the detector stage is in fashion a converter stage—high frequency current in S7-C7 is changed to audio frequency or zero-beat fre-

quency, respectively, for code and phone reception in the plate circuit of V2.

Now three other items command interest of a deep nature, but briefly theorized can be thus stated—condenser C4 holds the electric charge on the grid, while R4 permits this charge to leak off slowly, thereby creating an automatic grid bias. RFC2 is a coil identical with RFC1, for its purpose here is not to "load" the plate of V2, but to keep the creeping R.F. energy out of the audio transformer primary, and confining "serious trouble" to a limited space. (If allowed to "wander," the speaker might squeal if the cord is squeezed.)

It has been implicitly stated that due to the changes in grid voltage in the R.F. and detector stages, an identical change occurs in the plate current of coil P2 of the audio transformer T. It is this variation in the plate current through P2 that is heard from the speaker. The audio frequency transformer T greatly increases the voltage which exists across coil P2. If a 5:1 transformer, S2 voltage will be five times that of P2. With this S2 voltage applied to the grid-filament of tube V3, here again amplification of the detected (rectified) signal occurs, for V3 acts as an audio amplifier.

And lastly in theory is mentioned the speaker, which in fashion, too, is a converter device—the electrical changes which occur in the plate current of V3, by actuating electromagnets and diaphragm, produce energy in the form of sound waves. Be it noted that the "steady" plate

current creates no sound, but only the variable component.

The panel size is 7 x 12 inches and wood baseboard, 8 x 11 inches, the latter being mounted on $\frac{1}{2}$ x $\frac{1}{2}$ x 8 inch wood cleats.

Mounting Condensers

Though the three variable con-

densers on the panel make the set appear Babylonian, the beginner need not fear their price, for many companies now have on the market very compact midget condensers which have practically the same capacity (140 mmf.) as those shown in the illustration for the R.F. and detector stages. It might be supposed that ver-

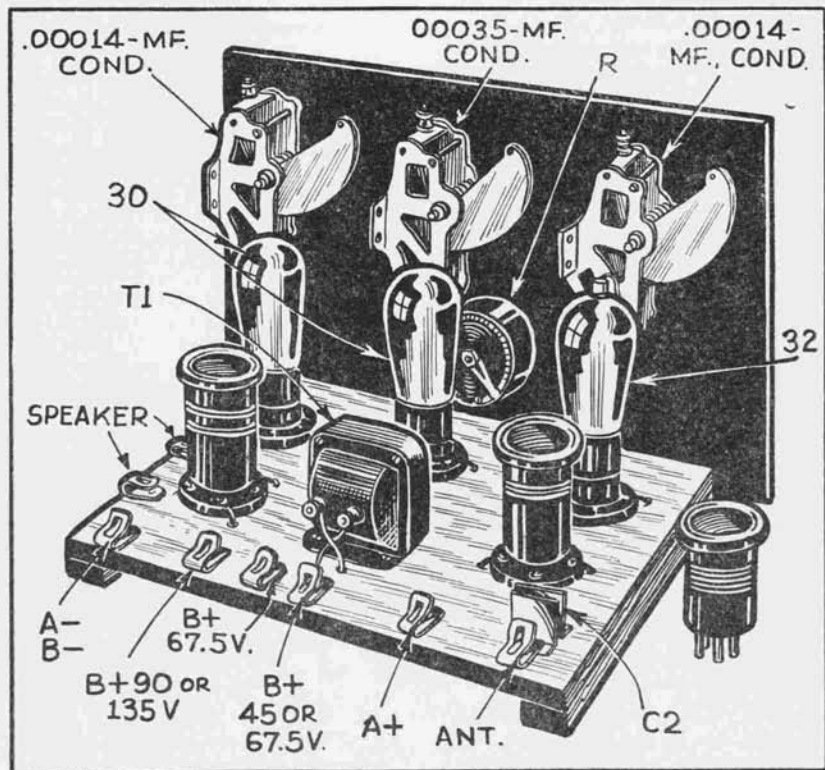

Completely Assembled "Signal Gripper."

nier dials would be necessary for tuning these stages, but the ease of tuning-in stations with common 2-inch dials on the condenser shafts (C, C7) can hardly be appreciated until the set is actually built and is doing its duty. For the position of the condensers, all are on the same level ($2\frac{1}{4}$ inches from top of panel) with the end ones $2\frac{1}{4}$ inches and the center one at the middle.

The three UX tube sockets for the tubes are mounted on the baseboard directly behind the panel variable condensers with about $\frac{1}{2}$ inch clearance and in line with these are the plug-in coil sockets, with each 4 inches from the center of the transformer, thus making the R.F. and detector stage coils 8 inches apart. A good reason exists for this distance. If coils S6 and S7 are too close, the coupling will be too "tight" and the set will give the R.F. "pop" or "howl." Thus the coupling between these two stages should be through condenser C3 and not between the coils.

Coil Details

Through an elaboration of constructional facts, the details for the coils have now appeared for consideration. These may be wound on the regular size *tube bases* and elsewhere in this article appears the necessary data for those who wish to "roll their own." However any good make of plug-in coils may be used and will give better results.

Several reasons may be mentioned why they are better—the forms are genuine bakelite, while a flock of tube bases today are more or less porous

composition material; if metal subpanels are used and the coils are too close to it (as would occur with tube bases) a great deal of the R.F. energy "shoots" to ground because of the *condenser action* between coil windings and subpanel, and the coils, as seen from the appreciative side, make a set appear more majestic.

Memorized Knowledge Proves Valuable

After constructing this set and trying to get it to work in a decent manner, "old man trouble" was not far away. There existed right at the point of maximum sensitivity that "pop" or "howl." At first it was thought to be due to the closeness of the R.F. and detector stage coils, but recalling that mistakes are made in the process of manufacture, the idea of correction was followed out to make things right. It is a well-known fact that when an audio transformer coil has reverse connections made to it, that coil will act as a "tickler" and due to its large value of inductance and capacitance, there results the audible (audio) "howl." Sure enough, that proved to be the "bugaboo," for the connections from the transformer coil had run to the wrong binding posts on the shell. Instead of the "P" terminal of V2 going to "P" on the transformer and "B" battery connection to B-plus on the same, connections were reversed with "B" battery going to "P" on the transformer and B-plus to "P" on the tube socket of V2. And "old man trouble" flew to another job, for the stations that poured in

with their melody indicated that his services were no longer required.

List of Parts for "Signal Gripper"

One Panel 7 x 12 inches;
 One baseboard, 8 x 11 inches;
 Two wood cleats, $\frac{1}{2}$ x $\frac{1}{2}$ x 8 ins.;
 Two .00014-mf. variable condensers (C6, C7) and 2-inch dials;
 One .00035-mf. variable condenser (C5) and 2-inch dials;
 Four pieces of sheet copper, 1 x $\frac{1}{4}$ inches (C2, C3);
 Five four prong sockets;
 One 5:1 transformer (T);
 Seven Fahnestock clips;
 Two R.F. chokes; 2.5 m.h.;
 One .0001-mf. grid condenser (C4);

One 5-megohm grid-leak (R4);

One 20-ohm rheostat (R);

Hook-up wire, screws, etc.

Coil Data

Range	Coil Turns		
	R.F.	S7	S8
15- 25 meters	4	4	4
24- 45 meter	8	8	5
40-110 meters	20	20	6

All coils wound with No. 24 D.C.C. copper wire. Note also the feature that the coils give ample tuning range for the 20, 40, 80 meter short-wave code and phone amateur bands.

ELECTRIFYING THE "DOERLE" 12,500 MILE RECEIVER

By G. W. Shuart

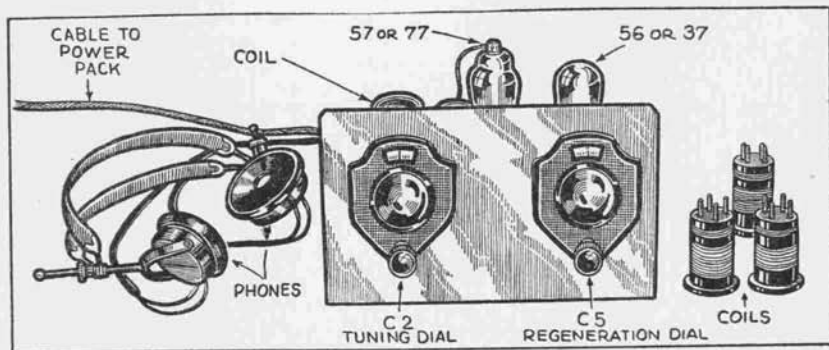

Front View of the A. C. 2-Tube "Doerle."

WITH all the fine reports from users of the famous "Doerle" receivers, the author decided to convert one of these receivers for A.C. operation using the new screen-grid pentode tubes. The results were so gratifying that it was decided to pass the information on to the readers of this book.

A commercial 2-tube model of this receiver was obtained for this purpose. This model uses two type 30, two-volt tubes; one as regenerative detector and another as transformer-coupled audio amplifier. The first operation is to remove all wiring, the two four-prong sockets for the two type 30 tubes, the filament rheostat, and the audio transformer; the four prong coil socket remains.

It might be well to mention at this point the list of parts necessary to do the job. They are as follows:

- One six-prong wafer socket;
- One five-prong wafer socket;
- One screen-grid tube shield. Type 50
- One 2,000 ohm fixed resistor, 1 watt;
- One 250,000 ohm fixed resistor, 1 watt
- One 2 meg. grid-leak type resistor;
- Two .1 mf. by-pass condenser;
- One .005 mf. fixed condenser;
- One 1 mf. by-pass condenser;
- One terminal strip—5 lugs.

The first of the above parts to be mounted are the two tube sockets. The six-prong socket is mounted in the center-hole and the five-prong socket in the hole nearest the phone terminal strip.

Next mount the terminal strip with the five lugs on it in the center of the base on the under side. The one mf. by-pass condenser is mount-

ed on the top side of the base in the position formerly occupied by the audio transformer. We are now ready to wire the set.

Hook-up "OK" for 2.5 or 6 Volt Tubes

Referring to the diagram it will be seen that the circuit is a straightforward regenerative one, with resistance-coupled audio amplifier stage and "throttle" (condenser) control of regeneration. There are no changes in the circuit originally used in the Doerle receiver, other than those necessary to the use of the new type tubes. Either the 2.5 volt or the 6 volt tubes can be used in the new receiver, *with no change in the circuit* being necessary, the results being the same in either case. If the builder wishes to stick to batteries, and still have the benefit of the new type tubes with their high "gain," the use of the 6 volt tubes is recommended. In this case the detector should be the type 77, with a type 37 for the audio. This is very practicable as the set will operate on as low as 90 volts on the plates, although better results are obtained with from 135 to 180 applied to the tubes. A storage battery is used for filament supply for these tubes and lasts quite some time due to their low filament current rating.

Plate Supply

For 110 volt A.C. operation a "power supply" is recommended; this should furnish 2.5 volts A.C. for the filaments, the *high-voltage* section supplying 180 volts, with a low volt-

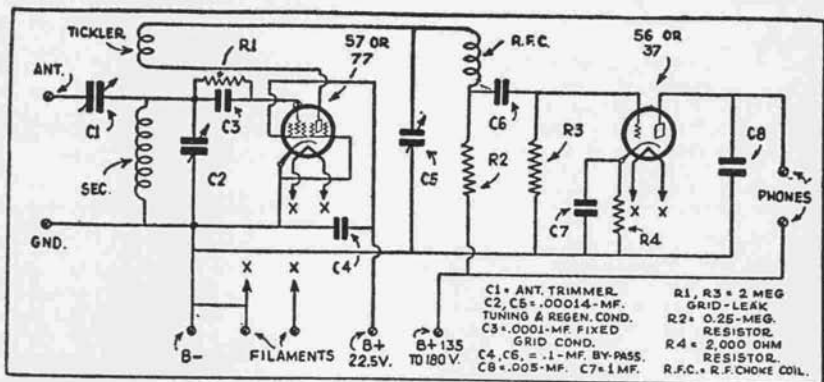

Schematic Diagram of the A. C. 2-Tube "Doerle."

age tap at 22 for the screen. This screen voltage is a very important point, as we are now controlling regeneration with a potentiometer in the screen-grid circuit, as is done in many other receivers. If this voltage is any higher than 22 volts the sensitivity of the receiver will be affected to a very great extent. Therefore one must remember, when the "throttle" condenser method of regeneration control is used with screen-grid tubes, the screen-grid voltage must be checked very carefully; otherwise poor results are liable to be experienced.

"B" Batteries may be used

If one wishes to use the 2.5 volt tubes and does not have on hand a regular power supply, a 2.5 volt filament transformer can be used to furnish the filament voltage with ordinary "B" batteries for the plate, (three, 45-volt batteries will operate

the set very nicely and last for a long time, as the plate current of this set is in the order of 7 milliamperes. The foregoing paragraphs will give the builder an idea of just how flexible this set really is.

Wiring the set is a very easy task, and if the diagram is followed carefully no difficulty should be experienced in getting the set to "perk." All connections should be soldered with rosin-core solder and a hot and well-tinned iron. File the sides of the iron when they become corroded and retin by rubbing the hot iron in flux and solder. (Rubbing it in sal-ammoniac or rosin and then applying solder is one of the old plumbers' tricks.) Only enough solder should be used to make a secure electrical connection. When the wiring is completed all connections should be traced and "double-checked" to make sure that no error has been made.

The standard coils that come with the receiver are used, however it may

be necessary to remove a few of the tickler turns on each coil, as the new tubes oscillate more easily than the type 30's formerly used in the set. This is best done by experimenting after the set has been tried. The symptoms of too many tickler turns are *violent and erratic operation* of

the *detector* when it goes into oscillation as the regeneration condenser is turned towards maximum capacity. Otherwise the operation of the receiver will be the same as before it was changed, the only difference being an extreme increase in signal strength over the two-volt tubes.

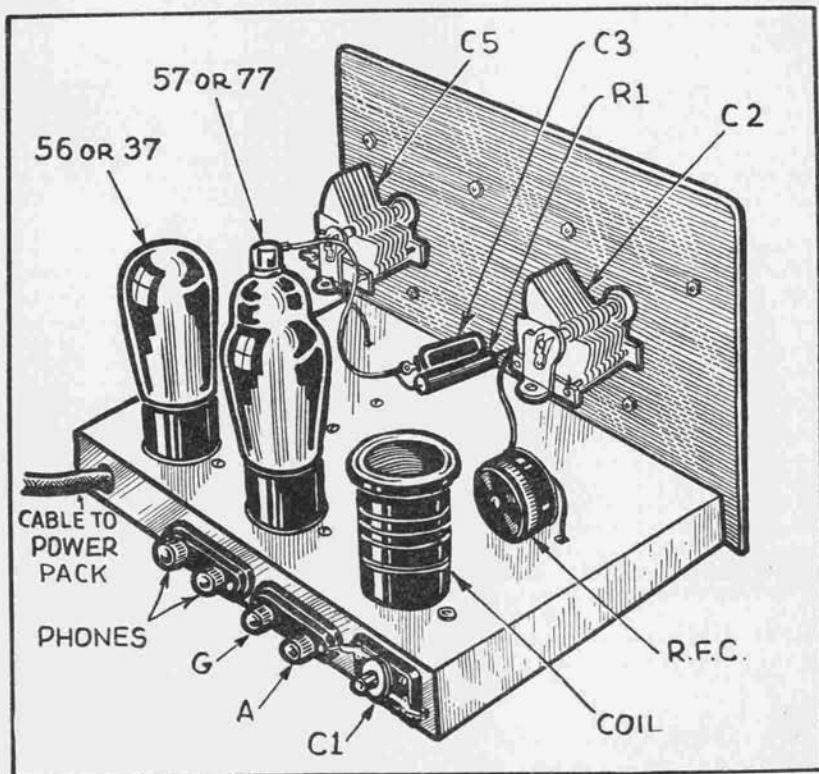

Rear View of the A. C. 2-Tube "Doerle."

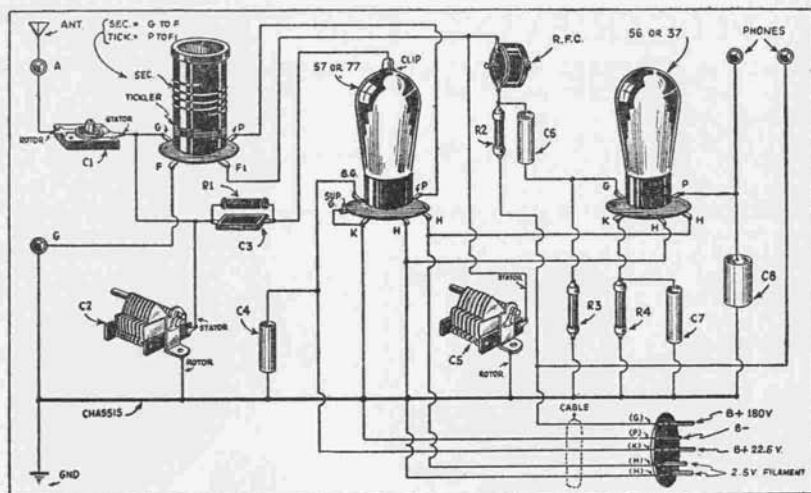

Pictorial Diagram Showing Placement of Parts.

The regeneration condenser is the one mounted on the left, the tuning condenser being mounted on the right. The antenna used with this receiver should be anywhere from 25 to 100 feet long, the longer antenna usually adds little to reception, other than an increase in background noise. If the set refuses to oscillate in some portions of the bands and oscillates well in others, it can be laid to absorption by the antenna. This can be readily overcome by an adjustment of the antenna trimmer condenser. If this condenser is coupled too closely the set will refuse to oscillate at all.

List of Parts

One antenna ground terminal strip;
One phone terminal strip;

One antenna trimmer cond. cap. about 100 mmf.;

One five wire cable;

One four prong socket (Eby; National; Hammerlund);

One five prong socket (Eby; National; Hammerlund);

One six prong socket (Eby; National; Hammerlund);

Two 2 meg. resistors (IRC);

One 250,000 ohm resistor (IRC);

One 2,000 ohm resistor (IRC);

One .0001 mf. mica grid condenser;

Two .1 mf. by-pass condenser;

One 1 mf. by-pass condenser;

One .006 mf. by-pass condenser;

One mounting strip (5 lugs);

One tube shield;

Two Hammerlund .00014 mf. tuning condenser.

Two 3-inch vernier dials.

ELECTRIFYING THE "DOERLE" 3-TUBE "SIGNAL GRIPPER"

By J. H. K. Brown

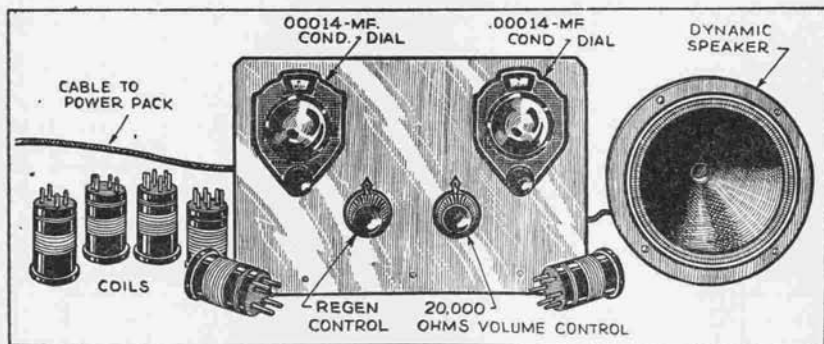

Front View of the Electrified 3-Tube "Signal Gripper."

IN view of the wonderful results obtained from the two-tube Doerle receiver, using the new type tubes, described elsewhere in this book by Mr. G. Shuart, the author decided to electrify the three-tube model, and present it to the readers of this book.

The set described in this article is truly a wonderful short-wave receiver. Foreign short-wave stations can be brought in loud enough to operate a speaker even with only a triode (3-element tube) used in the output stage. If a *pentode* were used greater volume would be obtained, but then headphones would be out of the picture, and the author just can't

seem to break away from phones, which are really the best for "DX" short-wave reception.

How to Change Battery Model

For those who already have the three-tube set, the operation of changing to the new type tubes is as follows. Remove all wiring, all sockets except the four-prong one on the left side of the chassis (front view) which is used for the R.F. coil. Remove the 20 ohm rheostat and replace it with a 20,000 ohm unit, which will be used for volume control. The additional parts that will be needed to convert this set are:

One set of six-prong, three-winding coils;

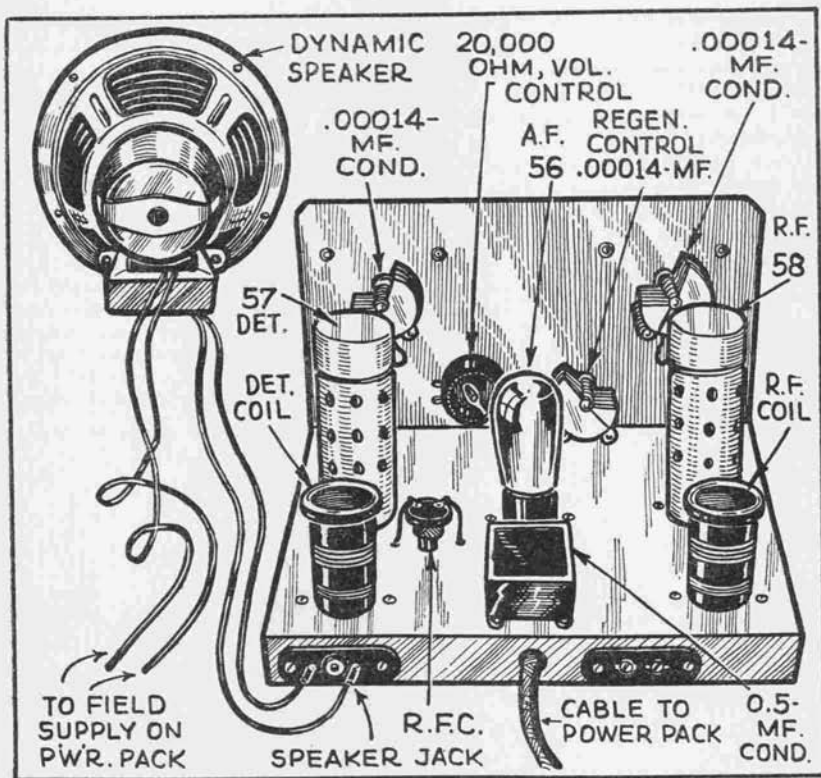

Rear View of Electrified "Signal Gripper."

Instead of coupling the antenna directly to the grid of the R.F. tube, as is done in the old receiver, the antenna winding on the R.F. coil that was unused is now employed to couple the antenna to the set.

Mount all the parts, following the same layout as in the old re-

ceiver, except that the audio transformer is not used. *Resistance coupling* is used instead because of the high plate impedance of the detector tube. Solder all connections with a hot and well-tinned iron, using pure non-corrosive rosin-core solder.

Various Sources of Power Usable

This receiver can be operated from various sorts of power supply arrangements and is adaptable to any location whether A.C. power is available or not. For those having A.C. power it is suggested that this set be run from a regular power supply, delivering from 180 to 250 volts with a 2.5 volt filament winding. A 22 volt tap will be required for the screen of the detector tube, of course. It might be well to state here that the voltage applied to the screen should not exceed 22 volts under any consideration, because the sensitivity of the receiver will be very much affected by running the

screen at a higher potential. Also the regeneration control will not operate smoothly if the voltage is not of this value. If one wishes to operate this set from batteries it can be done very nicely with no change in the circuit. It's just a matter of changing the tubes to the automobile type and running them from a six-volt storage battery and using "B" batteries for the plate supply. 135 volts will work very nicely, although higher voltage is recommended if full signal strength is to be had. For operating on a regular power supply from 110 volts A.C., a 58 will be needed for the tuned R.F. stage,

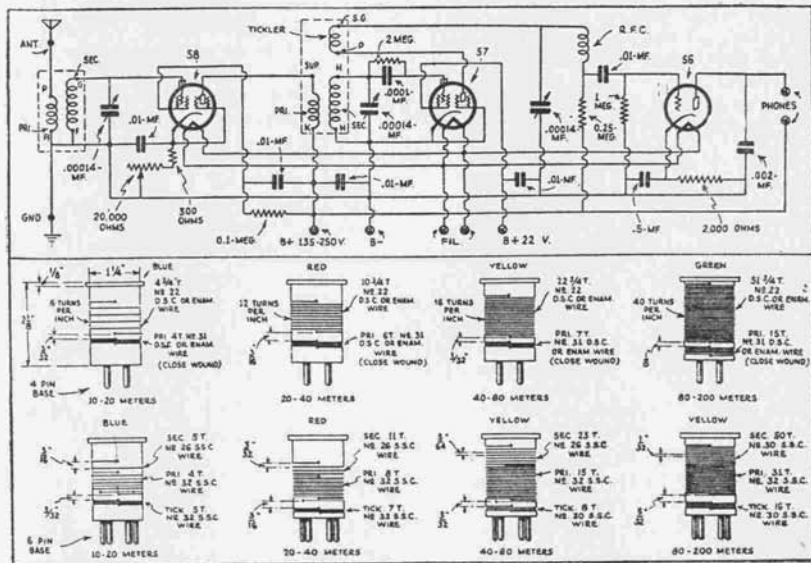

Schematic Diagram and Coil-Winding Data.

a 57 for the detector, and a 56 as the output tube. When operating from a storage battery with "B" batteries for the plate supply, a 78 will be used for the R.F. tube, a 77 for the detector and a 37 for the audio tube.

Operation

The operation of this receiver is exactly the same as before it was changed, as far as tuning is concerned. The two tuning condensers will have to be tuned at the same time, and the stations formerly received on this set will be received on practically the same dial settings, because the new coils tune exactly the same as the old ones. Tuning of the R.F. stage, however, will be much sharper than before; in fact the selectivity of the whole set is far greater than when it used the 2 volt type tubes.

List of Parts for the New "Doerle" 3-Tube A.C. Receiver

One drilled metal chassis;
One R.F. choke coil;
One set of (6-prong) special three-winding coils;

One set (4-prong) plug-in coils;
Five .01 mf. fixed condensers, Flechtheim;
One .002 mf. fixed condensers, Solar;
One .5 by-pass condenser, Solar;
One 300 ohm resistor;
One 100,000 ohm resistor, IRC;
One 250, 000 ohm resistor, IRC;
One 1 megohm resistor, IRC;
One 2 megohm resistor, IRC;
One 2,000 ohm resistor, IRC;
One 20,000 ohm resistor, Variable;
Three six prong sockets, Eby (National; Hammarlund; Na-ald);
One five prong socket, Eby (National; Hammarlund; Na-ald);
One four prong socket, Eby (National; Hammarlund; Na-ald);
Two triple grid tube shields, Hammarlund (National);
One .0001 fixed condenser, Solar;
Three Hammarlund .00014 mf. tuning condensers;
Two tuning dials, National or other make;
One antenna ground terminal strip, Eby;
One phone terminal strip, Eby;
One five wire cable

BAND-SPREADING THE 2-TUBE "DOERLE" RECEIVER

By G. W. Stuart

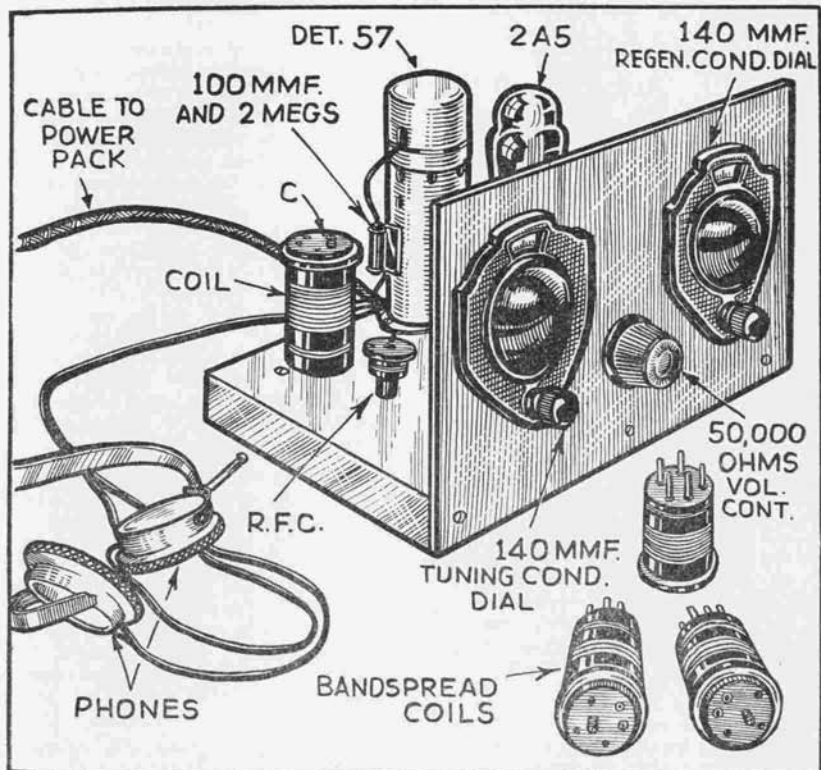

Front View of the Bandspread "Doerle" Set.

IT has been proven by the hundreds of letters received from short-wave constructors and experimenters, that the Doerle sets are among the most popular. Along with these letters have come the requests from a great number of amateurs asking that the 2-tube Doerle set be modified for amateur or "Ham" use. In order for any set to comply with amateur requirements it is necessary that the set spread the various "Ham bands" over a goodly portion of the tuning dial. Operation on the amateur bands with an ordinary receiver not having *band spread* is just about impossible, as the forty meter band, for instance, occupies only about five or six divisions of the dial and with the great congestion on this band this condition would be prohibitive.

Ham's Requirements Met

It is the purpose of this article to present a method by which the 2-tube electrified Doerle can be revamped to conform with the Ham's most rigid requirements, and also to serve as constructional information for any one wishing to build the set, if they have not already done so. For the amateur possessing a receiver of an older type and wishing to build something more satisfactory for his purpose, we can very highly recommend this little receiver. It is very economical to construct and will give most gratifying results.

The original receiver is described by the writer elsewhere in this book. This set used a type 57 detector and a 56 as the audio amplifier. While

this tube arrangement produced excellent results it was believed that there could be just a little more audio amplification to bring up those very weak signals. The new set utilizes a pentode amplifier, which will be discussed later.

New "Band-Spread" Coils Used

To introduce *band-spread* use is made of Meissner band-spread coils. The construction of these coils can be seen by referring to the drawing and also the wiring diagram. It will be noticed that they are five-prong coils having the regulation tickler and grid coil. The grid coil has been tapped and to obtain *band-spread* the main tuning condenser is connected across only a portion of the inductance. A small *padding condenser* has been mounted in the top of the coil form and this capacity is connected across the entire coil in order to obtain a stabilized tuning circuit. This capacity is also used to tune the coil so the band will appear in the center of the tuning dial.

The Meissner concern manufactures another set of the same type coils, which are designed to be used on the various short-wave "broadcast" bands. With these coils the short-wave "Fan" can have greater tuning ease on his favorite foreign broadcast band. The set described in this article, together with a set of the short-wave "broadcast" band-spread coils, would make an ideal combination.

For those who have already built the 2-tube electrified Doerle it will be a comparatively simple matter

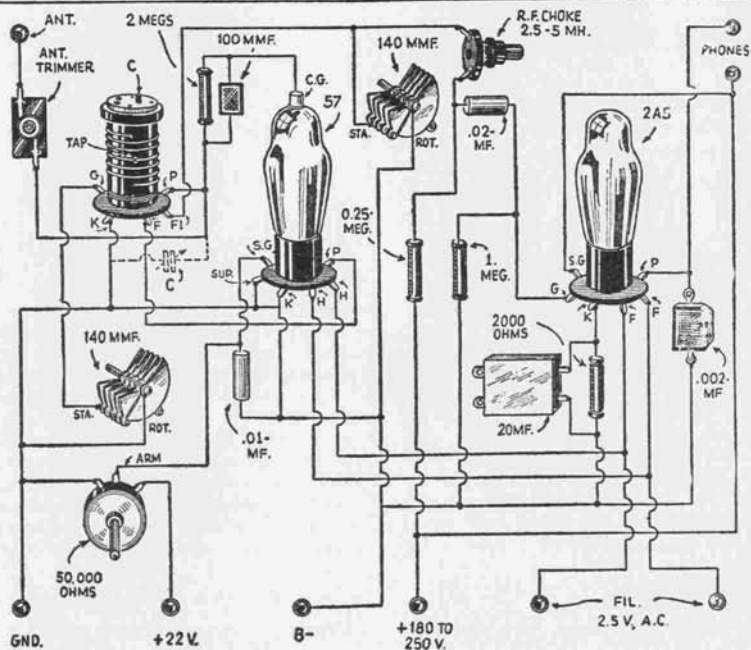
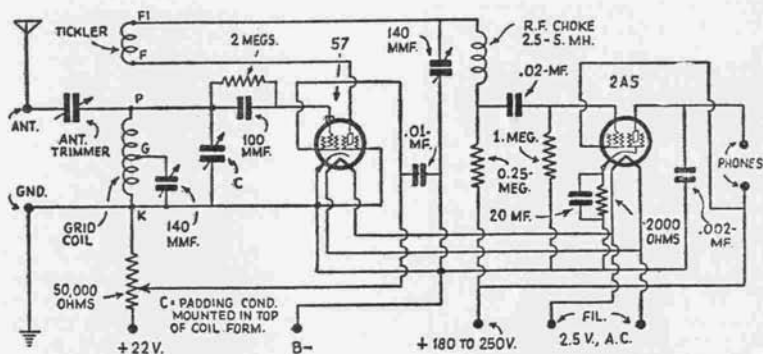

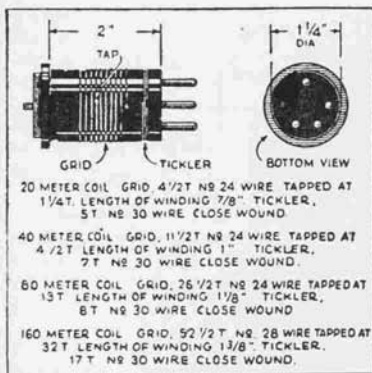

These coils are available commercially, but if you wish to "roll your own" here is all the data.

to make the simple changes outlined. The first procedure is to remove the four-prong coil socket and the five-prong tube socket. The four-prong socket will be discarded but the one used for the 56 tube will now be used for the five-prong band-spread coils, and is mounted where the four-prong socket was formerly located. It will be necessary to obtain a 6-prong wafer socket to accommodate the 2A5 pentode tube. This will be mounted in place of the one used before the 56. Mount the six-prong socket so that the filament terminals are facing the end of the chassis. The five-prong socket will be mounted with the filament holes toward the rear of the base. Mounting the sockets in this manner will simplify wiring to quite an extent. The rest is easy, just wire up the two sockets according to the diagram.

For the "Fans" who have not constructed the 2-tube Doerle, this

set offers about the ultimate in 2-tube receivers; the builder will be more than thrilled with the results obtainable with this little "band-spread" two-tuber.

Chassis

The metal chassis used in constructing this set is of the variety sold by nearly every mail-order house and comes completely drilled and finished in various colors of lacquer. These chassis are really cheaper to buy than to construct, and they present a more business-like appearance. The illustrations show the placement of the various parts and this general layout should be followed as closely as possible in constructing the set.

It will be noticed that there are two more changes in the new version of the Doerle, viz.: the addition of a potentiometer in the screen-grid of the detector tube, and the 57 detector is provided with a shield. The potentiometer was added because various makes of 57 tubes require slightly different voltages on the screen-grid. And then again on the higher frequency bands, it has been found that a slight change in screen voltage is necessary to obtain smooth regeneration. Then in many cases the builder may not have provisions for adjusting the voltage from the power supply where the potentiometer permits the voltage to be set for maximum sensitivity. The regeneration is then controlled with the *throttle* condenser.

Detector Tube Shielded

When using a pentode, such as

the 2A5 tube, it is necessary to shield the detector tube in order to prevent *feed-back* between the two stages, which causes the pentode to howl. So don't forget to shield the detector tube! The same cathode biasing resistor that was used in the 56 amplifier of the original set is

used for the 2A5. While 500 ohms is the proper value for the 2A5 tube, the 2,000 ohm unit was used to lighten the load on the earphones, when used directly in the plate circuit of the pentode; the 2,000 ohm resistor provided less plate current to pass through the phones and the slight

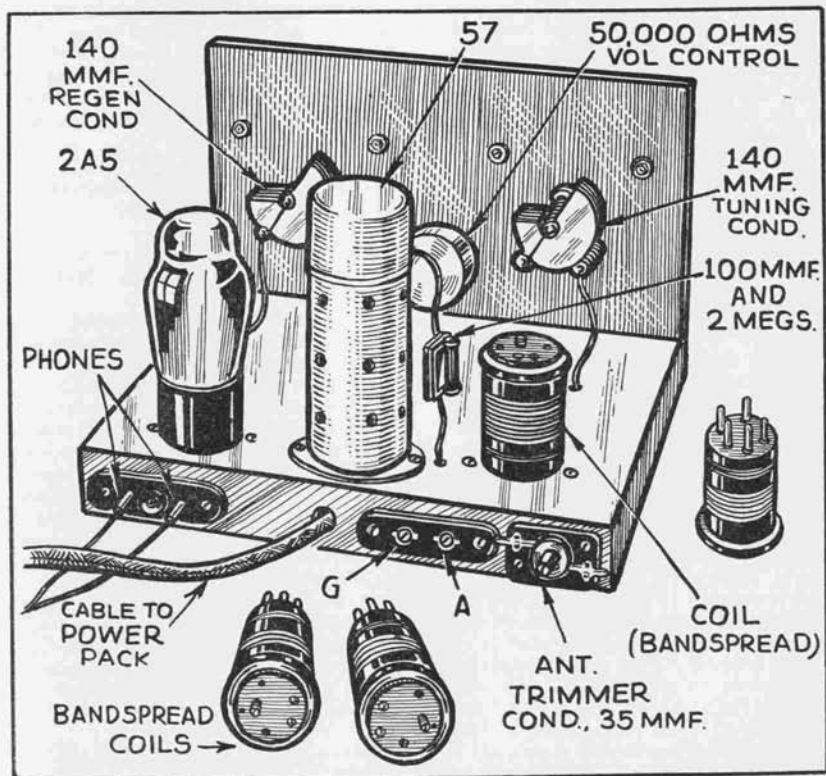

Rear View of the Bandspread "Doerle" Receiver.

difference in volume is nothing to worry about.

However, if an output transformer is available its use is preferred and then, of course, the 500, ohm resistor should be used. The by-pass condenser across this resistor should be one with a high capacity, around 20 mf. and with a working voltage of 20 to 25. This condenser will be necessary if full volume and natural tone is expected from the pentode. Another item that stabilizes the pentode and eliminates "fringe howl" is the *by-pass condenser from the plate to the B negative*. This condenser also reduces tube hiss to a minimum.

Check All Connections

After the set is wired up it is advisable to check all connections to make sure everything is firm and in its right place. Connect the power supply to the set and we are ready to hear some real 2-tube performance. Tuning is exactly the same as in the original set, except that the "band-setting" condenser mounted in the top of the coil form will have to be adjusted to bring the desired band within the range of the dial. This only needs to be done once on

each coil; after the adjustment has been made no further attention need be given to it.

Any type of antenna will work with this set. The length can be anywhere from 25 to 100 feet. The antenna coupling condenser of course will have to be adjusted for best results. It is best in the beginning to set this condenser to minimum capacity and make adjustments after the "feel" of the set is acquired. As for results—the foreign broadcasts come in on the speaker in most cases and amateurs can be brought in with astonishing volume.

Parts List—2-Tube Doerle Band-Spread

- 1 Set of Meissner "band-spread" coils.
- 1 drilled metal chassis. Meissner Mfg. Co.
- 2 140 mmf. variable tuning condensers. Hammarlund (National);
- 1 antenna trimmer (low min. cap.) 35 mmf. max
- 1 .0001 mf. mica condenser. Aerovox
- 1 .01 mf. bypass condenser. Aerovox
- 1 .02 mf. bypass condenser. Aerovox
- 1 .002 mf. bypass condenser. Aerovox
- 1 20 to 25 mf. 25-volt electrolytic condenser. (Aerovox)

HUM—FREE A. C. POWER PACK FOR SHORT-WAVE RECEIVERS

By Leonard Victor

One of the most common bugaboos that the set builder runs across is hum in receivers. Peculiarly enough most constructors never give the power source much consideration. Yet, it is the life-supply for the set, the power-plan that supplies the "juice" to make the wheels go round! Most packs that I have seen were hay-wire affairs thrust off on the floor or the bottom shelf of a table, with leads running every which way from them.

The little pack shown and described is one that I made up for testing purposes around the "shack," and although it did not cost eight dollars in its entirety, still up to 300 volts of pristine pure, direct current at 60 mills is available when needed, and likewise $2\frac{1}{2}$ volts at any current up to ten amperes. The layout of the pack can be clearly seen from the picture and schematic diagram.

There is nothing unconventional in any part of the pack circuit. A midget power transformer provides the high voltage, rectifier filament voltage, and the $2\frac{1}{2}$ volt winding for filament supply on the unit with which the pack is used. A 280 is used as a conventional full-wave rectifier, followed by a two section filter system and a bled resistor. The "B" and filament currents are

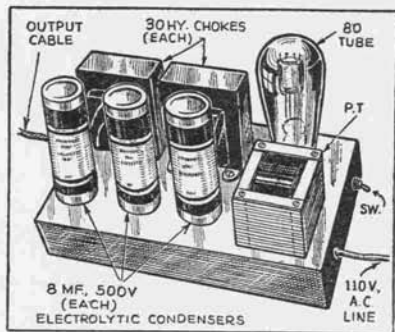

The Completely Assembled Short-Wave Power Unit. Note Compactness.

connected to a five-foot cable which is used for connection to sets. The filter system consists of three 8 mf. electrolytics and two 30 henry, 100 M.A. chokes. The following are general truths that can always be followed in choosing apparatus for power supplies.

Transformers

When purchasing a power transformer for a receiver, make sure that it will supply enough current for all the tubes in the receiver. For instance, if the set is a four tuber, with a '47 in the output, it will draw about forty milliamperes. Hence the rating

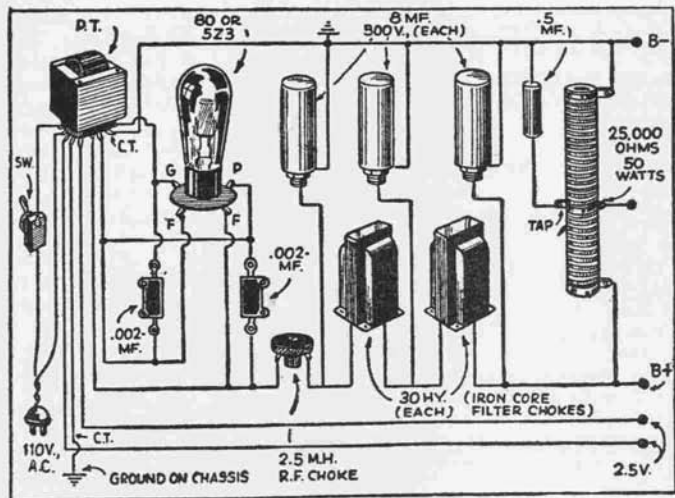

This Pictorial Diagram will permit newcomers to build the short-wave power unit without any difficulty.

of the high voltage winding should be at least 50 mills (M.A) at the required voltage (300). For short-wave work, the best type of transformer is one that has an electrostatic shield. This is a winding between the primary and high-voltage winding, which is connected to the core of the transformer and grounded; this shield frequently eliminates annoying hums. Likewise be sure that the filament winding on the transformer will supply sufficient amperage for the set. Even the cheapest of transformers will stand some overloading, but it is good practice, and eliminates quite a few "head-aches" if all apparatus is run *underloaded*. If the transformer is to be used, reused, and then once more reused, (as in most experimental shacks), get one with soldering lugs,

as the type with wire leads will perhaps cause trouble in some instances, due to too short a lead or frayed and sloppy connections.

The Rectifier

An 80 is the most common choice for the rectifier, but if there is to be a heavy drain and the transformer is built to give a 3-ampere, 5-volt-winding, a 5Z3 should be used. The 5Z3 is the big brother to the 80, and will give more current, with lower voltage drop in the tube. Never use mercury vapor tubes, such as the 82 and the 83, as this is only courting trouble from various types of *hums*.

Filter System

The filter system consists usually of condensers across the positive and negative output of the transformer—rectifier system, with chokes in series

with either the negative or positive lead. Electrolytic condensers are the most compact type, and being generally made with a 500 volt rating will usually be good enough for any receiver power supply. One caution though. Always be sure to buy a standard, reputable make of condenser. I had one of the surprises of my life when I saw several cheap brand of so-called 8 mf. electrolytics put across a capacity meter, while in operation. Their capacities ranged anywhere from two to five mikes un-

der operating conditions! Likewise, cheap condensers usually have short life, and after a year or so will have to be yanked out and replaced. Chokes should be 30 henry units capable of carrying the current needed. If the pack is to supply 60 mills (M.A.), a choke with a 100 mill rating at thirty henries should be used. Again, as with the condensers, do not buy cheap chokes.

Bleeder Resistor

For a pack up to 350 volts, a 25,-

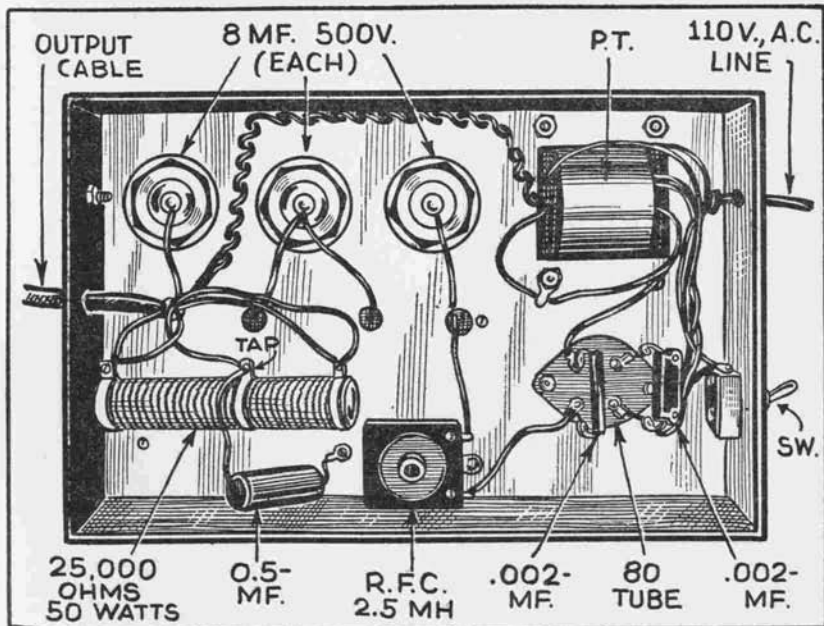

Underside View of Power Unit Showing Correct Placement of Parts.

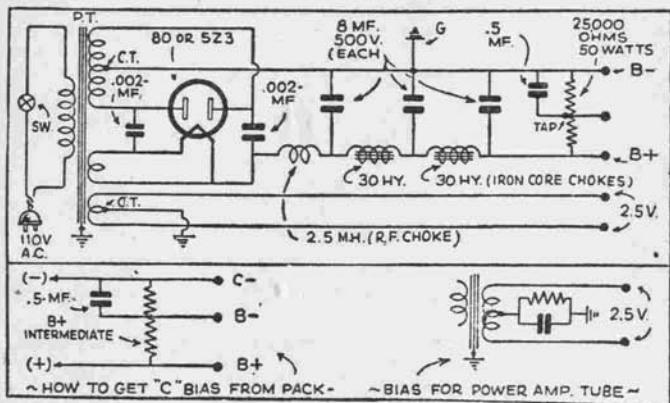

Schematic diagram for Short-wave Power Pack with incidental details for obtaining bias voltages.

000 ohm 50 watt resistor is the best bleeder. Sliders on the resistor will provide any desired voltage between high and ground. Remember to *bypass* every tap to ground, through a condenser, even if it is by-passed in the set. Should it be desired to 'get "C" bias from the pack, it is only necessary to use some point above ground as "B" minus and the remainder of the resistor back to the negative point on pack will be minus potential. This is shown in an accompanying diagram. To obtain bias for a power tube, such as a '45 or a '47, a resistor is put in series with the filament center-tap. This resistor is bypassed by a high capacity, low-voltage condenser, generally 5 or 10 mf. rated at 50 volts. The circuit for this is shown in the diagram. For a single 245, the resistor should be 1500 ohms! for a 47, 450 ohms. The resistor should be of 5 watt rating, wire-wound.

Remember to always use a *good* ground and be sure that all chokes and transformers are *grounded* to the chassis. Likewise always to ground the center-tap of all filament windings, even if they are only *sparcs* that are not being used on the set.

Parts List—Doerle Power Supply

- 1—Chassis, 6x9x2 inches.
- 1—Power transformer, 325-0-325 V., 70 ma. 2½ volts, 5 volts,
- 2—30 henry filter chokes, 70 ma.
- 3—8 mf. electrolytic condensers (500 V.)
- 1—½ mf. condenser (200 V.)
- 1—25,000 ohm, 50 watt voltage divider. (With slider.)
- 2—.002 mf. mica condensers.
- 1—R.F. choke. 2.5. M.H. Hammarlund.
- 1—4 prong wafer socket.
- 1—"On"—"Off" switch.
- 1—type 80 or 5Z3 RCA Radiotron.

Four Recent Additions to the GERNSBACK'S EDUCATIONAL LIBRARY

No. 5—BEGINNERS' RADIO DICTIONARY



Are you puzzled by radio language? Can you define frequency? Kilocycle? Tetrode? Screen grid? Baffle? If you cannot define these very common radio words and dozens of other, more technical, terms used in all radio magazines and instruction books, you need this book in your library. It's as modern as tomorrow—right up to the minute. It tells you in simple language just what the words that puzzle you really mean. You cannot fully understand the articles you read unless you know what radio terms mean. This is the book that explains the meanings to you. Can you afford to be without it, even one day longer?

No. 6—HOW TO HAVE FUN WITH RADIO

Stunts for parties, practical jokes, scientific experiments and other amusements which can be done with your radio set are explained in this fascinating volume. It tells how to make a newspaper talk—how to produce silent music for dances—how to make visible music—how to make a "silent radio" unit, usable by the deafened—how to make toys which dance to radio music—sixteen clever and amusing stunts in all. Any of these can be done by the novice, and most of them require no more equipment than can be found in the average home. Endless hours of added entertainment will be yours if you follow the instructions given in this illustrated book.



No. 7—HOW TO READ RADIO DIAGRAMS



The symbols commonly used in radio diagrams are presented in this book—with pictures of apparatus they represent and explanations given an easy method to memorize them. This book, by Robert Eichberg, member of the editorial staff of RADIO-CRAFT, contains two dozen picture wiring diagrams and two dozen schematic diagrams of simple radio sets that you can build. Every diagram is completely explained in language which is easily understood by the radio beginner. More advanced radio men will be interested in learning the derivation of diagrams, and the many other interesting facts which this book contains.

No. 8—RADIO FOR BEGINNERS

Hugo Gernsback, internationally famous radio pioneer, author and editor, whose magazines, RADIO AND TELEVISION and RADIO-CRAFT are read by millions, scores another triumph. Beginners who read it get thorough ground work in radio theory, clearly explained in simple language, and through the use of illustrations. Analogies make things as simple as "2-1-2 is 4." It contains diagrams and instructions for building simple sets, suitable for the novice. If you want to know how transmitters and receivers work, how radio waves traverse space, and other interesting facts about modern communication, this is the book for you!



BOOKS ARE ALL UNIFORM

10c Each

Every book in the GERNSBACK'S EDUCATIONAL LIBRARY has 32 pages—with illustrations varying from 30 to 66 in number. Each title volume contains over 15,000 words. **POSITIVELY THE GREATEST 10c VALUE IN RADIO BOOKS EVER OFFERED TO THE PUBLIC.**

Order books by number—remit by check, money order, cash or unused U. S. Postage Stamps. Books are mailed **POSTPAID.**

RADIO PUBLICATIONS • 101 HUDSON ST. • NEW YORK, N. Y.

Here Are Additional Titles in the Famous GERNSBACK'S EDUCATIONAL LIBRARY:



No. 2—HOW TO MAKE THE MOST POPULAR ALL-WAVE 1- and 2-TUBE RECEIVERS

There has been a continuous demand right along for a low-priced book for the radio experimenter, radio fan, radio Service Man, etc., who wishes to build 1- and 2-tube all-wave sets powerful enough to operate a loud-speaker. This book contains a number of excellent sets, some of which have appeared in past issues of RADIO-CRAFT. These sets are not toys but have been carefully engineered. They are not experiments. To mention only a few of the sets the following will give you an idea.

The Megadyne 1-Tube Pentode Loudspeaker Set, by Huro Gernsback. Electrifying the Megadyne. How To Make a 1-Tube Loud-Speaker Set, by W. P. Chesney. How To Make a Simple 1-Tube All-Wave Electric Set, by F. W. Harris. How To Build A Four-In-Two All-Wave Electric Set, by J. T. Bernsley, and others.

No. 3—ALTERNATING CURRENT FOR BEGINNERS

This book contains everything to give the beginner a foothold in electricity and Radio. Electric circuits are explained. Ohm's Law, one of the fundamental laws of radio, is explained; the generation of alternating current; sine waves; the units—volts, amperes, and watts are explained. Condensers, transformers, A.C. instruments, motors and generators—all these are thoroughly discussed. Housewiring systems, electrical appliances and electric lamps.

Here are some of the practical experiments which you can perform at home. Simple tests for differentiating between alternating and direct current; how to light a lamp by induction; making a simple electric horn; demagnetizing a watch; testing motor armatures; charging storage batteries from A.C. outlet; testing condensers with A.C.; making A.C. electro magnets; frying eggs on a cake of ice; making simple A.C. motors and many others.



No. 4—ALL ABOUT AERIALS

In simple, understandable language this book explains the theory underlying the various types of aerials; the inverted "L," the Doublet, the Doublet, etc. It explains how noise-free reception can be obtained, how low-impedance transmission lines work; why transposed lead-ins are used. It gives in detail the construction of aerials suitable for longwave broadcast receivers, for short-wave receivers, and for all-wave receivers. The book is written in simple style. Various types of aerials for the amateur transmitting station are explained, so you can understand them. It eliminates, once and for all the confusion about the type of aerial to choose for best broadcast and short-wave reception. For the thousands of radio fans, both short-wave and broadcast, who wish to know just what type of antenna they should use and why, this book has been especially published.



BOOKS ARE ALL UNIFORM

10c Each

Every book in the GERNSBACK'S EDUCATIONAL LIBRARY has 32 pages—with illustrations varying from 30 to 66 in number. Each title volume contains over 15,000 words. **POSITIVELY THE GREATEST 10c VALUE IN RADIO BOOKS EVER OFFERED TO THE PUBLIC.**

Order books by number—remit by check, money order, cash or unused U. S. Postage Stamps. Books are mailed **POSTPAID.**

RADIO PUBLICATIONS • 101 HUDSON ST. • NEW YORK, N. Y.